



**3100** PSI  
2.6 GPM

PROFESSIONAL

## OPERATOR'S MANUAL

Record all information and attach sales receipt here for future reference.

Purchase Date: \_\_\_\_\_

Serial Number: \_\_\_\_\_

# Pressure Washer MegaShot V3100

Visit us at [www.power-washer.us](http://www.power-washer.us) to register your warranty, find replacement parts, and talk with our service representatives about your pressure washer.

Table of Contents	
Safety Guidelines / Definitions	2
Important Safety Instructions	2-7
Specifications	7
Carton Contents	8
Assembly Instructions	8-9
Operating Instructions	9-13
Maintenance	14
Storage	15
Repairs	15
Accessories	16
Trouble Shooting Guide	16-17
Warranty	18-19



### IMPORTANT

*Please make certain that the person who is to use this equipment carefully reads and understands these instructions before operating.*

REV. 3 4/10

## SAFETY GUIDELINES - DEFINITIONS

This manual contains information that is important for you to know and understand. This information relates to protecting YOUR SAFETY and PREVENTING EQUIPMENT PROBLEMS. To help you recognize this information, we use the symbols below. Please read the manual and pay attention to these symbols.

**▲DANGER:** Indicates an imminently hazardous situation which, if not avoided, will result in death or serious injury.

**▲WARNING:** Indicates a potentially hazardous situation which, if not avoided, could result in death or serious injury.

**▲CAUTION:** Indicates a potentially hazardous situation which, if not avoided, may result in minor or moderate injury.

**CAUTION:** Used without the safety alert symbol indicates a potentially hazardous situation which, if not avoided, may result in property damage.

## CONSUMER SAFETY INFORMATION

### ▲WARNING:

This product may not be equipped with a spark arresting muffler. If the product is not equipped and will be used around flammable materials, or on land covered with materials such as agricultural crops, forest, brush, grass, or other similar items, then an approved spark arrester must be installed and is legally required in the State of California. It is a violation of California statutes section 130050 and/or sections 4442 and 4443 of the California Public Resources Code, unless the engine is equipped with a spark arrester, as defined in section 4442, and maintained in effective working order. Spark arresters are also required on some U.S. Forest Service land and may also be legally required under other statutes and ordinances.

### ▲WARNING:

This product contains chemicals, known to the State of California, to cause cancer, and birth defects or other reproductive harm. Wash hands after handling.

## IMPORTANT SAFETY INSTRUCTIONS

### ▲WARNING:

Do not operate this unit until you have read and understand this Operators Manual and the Engine Owners Manual for Safety, Operation, and Maintenance Instructions.

### READ AND SAVE THESE INSTRUCTIONS



**▲DANGER:** RISK OF EXPLOSION OR FIRE

WHAT CAN HAPPEN	HOW TO PREVENT IT
<ul style="list-style-type: none"> <li>Spilled gasoline and its vapors can become ignited from cigarette sparks, electrical arcing, exhaust gases and hot engine components such as the muffler.</li> </ul>	<ul style="list-style-type: none"> <li>Shut off engine and allow it to cool before adding fuel to the tank.</li> <li>Use care in filling tank to avoid spilling fuel. Move pressure washer away from fueling area before starting engine.</li> </ul>

WHAT CAN HAPPEN	HOW TO PREVENT IT
<ul style="list-style-type: none"> <li>• Heat will expand fuel in the tank which could result in spillage and possible fire explosion.</li> </ul>	<ul style="list-style-type: none"> <li>• Fill tank to 1/2" (12.7mm) below bottom of filler neck to provide space for fuel expansion.</li> </ul>
<ul style="list-style-type: none"> <li>• Operating the pressure washer in an explosive environment could result in a fire.</li> </ul>	<ul style="list-style-type: none"> <li>• Operate and fuel equipment in well-ventilated areas free from obstructions. Equip areas with fire extinguishers suitable for gasoline fires.</li> </ul>
<ul style="list-style-type: none"> <li>• Materials placed against or near the pressure washer can interfere with its proper ventilation features causing overheating and possible ignition of the materials.</li> </ul>	<ul style="list-style-type: none"> <li>• Never operate pressure washer in an area containing dry brush or weeds.</li> </ul>
<ul style="list-style-type: none"> <li>• Muffler exhaust heat can damage painted surfaces, melt any material sensitive to heat (such as siding, plastic, rubber, vinyl, or the high pressure hose) and damage live plants.</li> </ul>	<ul style="list-style-type: none"> <li>• Always keep pressure washer a minimum of 4' (1.2m) away from surfaces (such as houses, automobiles, or live plants) that could be damaged from muffler exhaust heat.</li> </ul>
<ul style="list-style-type: none"> <li>• Improperly stored fuel could lead to accidental ignition. Fuel improperly secured could get into the hands of children or other unqualified persons.</li> </ul>	<ul style="list-style-type: none"> <li>• Store fuel in an OSHA-approved container, in a secure location away from your work area.</li> </ul>
<ul style="list-style-type: none"> <li>• Use of acids, toxic or corrosive chemicals, poisons, insecticides, or any kind of flammable solvent with this product could result in serious injury or death.</li> </ul>	<ul style="list-style-type: none"> <li>• Do not spray flammable liquids.</li> </ul>



**▲ DANGER:** RISK TO BREATHING (Asphyxiation)

WHAT CAN HAPPEN	HOW TO PREVENT IT
<ul style="list-style-type: none"> <li>• Breathing exhaust fumes will cause serious injury or death! Engine exhaust contains carbon monoxide, an odorless and deadly gas.</li> </ul>	<ul style="list-style-type: none"> <li>• Operate pressure washer in a well ventilated area. Avoid enclosed areas such as garages, basements, etc.</li> <li>• Never operate unit in a location occupied by humans or animals.</li> </ul>
<ul style="list-style-type: none"> <li>• Some cleaning fluids contain substances which could cause injury to skin, eyes, or lungs.</li> </ul>	<ul style="list-style-type: none"> <li>• Use only cleaning fluids specifically recommended for high-pressure washers. Follow manufacturers recommendations. Do not use chlorine bleach or any other corrosive compound.</li> </ul>



**▲DANGER:** RISK OF FLUID INJECTION AND LACERATION

WHAT CAN HAPPEN	HOW TO PREVENT IT
<ul style="list-style-type: none"> <li>Your pressure washer operates at fluid pressures and velocities high enough to penetrate human and animal flesh, which could result in amputation or other serious injury. Leaks caused by loose fittings or worn or damaged hoses can result in injection injuries. <b>DO NOT TREAT FLUID INJECTION AS A SIMPLE CUT!</b> See a physician immediately.</li> </ul>	<ul style="list-style-type: none"> <li>Inspect the high-pressure hose regularly. Replace the hose immediately if it is damaged, worn, has melted from contacting the engine, or shows any signs of cracks, bubbles, pinholes, or other leakage. Never grasp a high-pressure hose that is leaking or damaged.</li> <li>Never touch, grasp, or attempt to cover a pinhole or similar water leak on the high pressure hose. The stream of water IS under high pressure and WILL penetrate skin.</li> <li>Never place hands in front of nozzle.</li> <li>Direct spray away from self and others.</li> <li>Make sure hose and fittings are tightened and in good condition. Never hold onto the hose or fittings during operation.</li> <li>Do not allow the high pressure hose to contact the muffler.</li> <li>Never attach or remove wand or hose fittings while system is pressurized - squeeze trigger gun (when engine is off) to relieve pressure in the system.</li> </ul>
<ul style="list-style-type: none"> <li>Injuries can result if system pressure is not reduced before attempting maintenance or disassembly.</li> </ul>	<ul style="list-style-type: none"> <li>To relieve system pressure, shut off engine, turn off water supply and pull gun trigger until water stops flowing.</li> <li>Use only hoses and accessories rated for pressure higher than your pressure washer's PSI.</li> </ul>



**▲DANGER:** RISK OF INJURY FROM SPRAY

WHAT CAN HAPPEN	HOW TO PREVENT IT
<ul style="list-style-type: none"> <li>High velocity fluid spray can cause objects to break, propelling particles at high speed.</li> <li>Light or unsecured objects can become hazardous projectiles.</li> </ul>	<ul style="list-style-type: none"> <li>Always wear ANSI-approved Z87.1 safety glasses. Wear protective clothing to protect against accidental spraying.</li> <li>Never point wand at, or spray people or animals.</li> <li>Always secure trigger lock when wand is not in service to prevent accidental operation.</li> <li>Never permanently secure trigger in pull-back (open) position.</li> </ul>



**⚠ DANGER: RISK OF UNSAFE OPERATION**

WHAT CAN HAPPEN	HOW TO PREVENT IT
<ul style="list-style-type: none"><li>• Unsafe operation of your pressure washer could lead to serious death to you or others.</li></ul>	<ul style="list-style-type: none"><li>• Do not use chlorine bleach or any other corrosive compound.</li><li>• Become familiar with the operation and controls of the pressure washer.</li><li>• Keep operating area clear of all persons, pets, and obstacles.</li><li>• Do not operate the product when fatigued or under the influence of alcohol or drugs. Stay alert at all times. Never defeat the safety features of this product.</li><li>• Do not operate machine with missing, broken, or unauthorized parts.</li><li>• Never leave wand unattended while unit is running.</li></ul>
<ul style="list-style-type: none"><li>• If proper starting procedure is not followed, engine can kickback causing serious hand and arm injury.</li></ul>	<ul style="list-style-type: none"><li>• If engine does not start after two pulls, squeeze trigger of gun to relieve pump pressure. Pull starter cord slowly until resistance is felt. Then pull cord rapidly to avoid kickback and prevent hand or arm injury.</li></ul>
<ul style="list-style-type: none"><li>• The spray gun/wand is a powerful tool that could look like a toy to a child</li></ul>	<ul style="list-style-type: none"><li>• Keep children away from the pressure washer at all times.</li></ul>
<ul style="list-style-type: none"><li>• Reactive force of spray will cause gun/wand to kickback, and could cause the operator to slip and fall or misdirect the spray. Improper control of gun/wand can result in injuries to self and others.</li></ul>	<ul style="list-style-type: none"><li>• Do not overreach or stand on an unstable support.</li><li>• Do not use pressure washer while standing on a ladder.</li><li>• Grip gun/wand firmly with both hands. Expect the gun to kickback when triggered</li></ul>





**⚠ DANGER:** RISK OF INJURY OR PROPERTY DAMAGE WHEN TRANSPORTING OR STORING

WHAT CAN HAPPEN	HOW TO PREVENT IT
<ul style="list-style-type: none"> <li>Fuel or oil can leak or spill and could result in fire or breathing hazard. Serious injury or death can result. Fuel or oil leaks will damage carpet, paint, or other surfaces in vehicles or trailers.</li> </ul>	<ul style="list-style-type: none"> <li>If the pressure washer is equipped with a fuel shut-off valve, turn the valve to the OFF position before transporting to avoid fuel leaks. If the pressure washer is not equipped with a fuel shut-off valve, drain the fuel from the tank before transporting. Only transport fuel in an OSHA-approved container. Always place pressure washer on a protective mat when transporting to protect against damage to vehicle from leaks. Remove pressure washer from vehicle immediately upon arrival at your destination.</li> </ul>



**⚠ WARNING:** RISK OF BURSTING

WHAT CAN HAPPEN	HOW TO PREVENT IT
<ul style="list-style-type: none"> <li>Over inflation of tires could result in serious injury and property damage.</li> </ul>	<ul style="list-style-type: none"> <li>Use a tire pressure gauge to check the tires pressure before each use and while inflating tires</li> <li>See the tire sidewall for the correct tire pressure.</li> <li><b>NOTE:</b> Air tanks, compressors, and similar equipment used to inflate tires can fill small tires similar to these very rapidly. Adjust pressure regulator on air supply to no more than the rating of the tire pressure. Add air in small increments and frequently use the tire gauge to prevent over inflation.</li> </ul>
<ul style="list-style-type: none"> <li>High velocity fluid spray directed at pneumatic tire sidewalls (such as found on automobiles, trailers, and the like) could damage the sidewall resulting in serious injury.</li> </ul>	<ul style="list-style-type: none"> <li>On pressure washers rated above 1600 PSI (110 Bar) use the widest fan spray (40° nozzle) and keep spray a minimum of 8" (20cm) from the pneumatic tire sidewall. Do not aim spray directly at the joint between the tire and rim.</li> </ul>



**⚠ WARNING:** RISK OF HOT SURFACES

WHAT CAN HAPPEN	HOW TO PREVENT IT
<ul style="list-style-type: none"> <li>Contact with hot surfaces, such as engine exhaust components, could result in serious injury.</li> </ul>	<ul style="list-style-type: none"> <li>During operation, touch only the control surfaces of the pressure washer. Keep children away from the pressure washer at all times. They may not be able to recognize the hazards of this product.</li> </ul>



**▲WARNING:** RISK OF CHEMICAL BURN

WHAT CAN HAPPEN	HOW TO PREVENT IT
<ul style="list-style-type: none"> <li>• Use of acids, toxic or corrosive chemicals, poisons, insecticides, or any kind of flammable solvent with the product could result in injury or death.</li> </ul>	<ul style="list-style-type: none"> <li>• Do not use acids, gasoline, kerosene, or any other flammable material in this product. Use only household detergents, cleaners, and degreasers recommended for use in pressure washers.</li> <li>• Wear protective clothing to protect eyes and skin from contact with sprayed materials.</li> </ul>



**▲WARNING:** RISK OF ELECTRICAL SHOCK

WHAT CAN HAPPEN	HOW TO PREVENT IT
<ul style="list-style-type: none"> <li>• Spray directed at electrical outlets or switches, or objects connected to an electrical circuit, could result in a fatal electrical shock.</li> </ul>	<ul style="list-style-type: none"> <li>• Unplug any electrically operated product before attempting to clean it. Direct spray away from electric outlets and switches.</li> </ul>



**▲WARNING:** RISK OF INJURY FROM LIFTING

WHAT CAN HAPPEN	HOW TO PREVENT IT
<ul style="list-style-type: none"> <li>• Serious injury can result from attempting to lift too heavy an object.</li> </ul>	<ul style="list-style-type: none"> <li>• The pressure washer is too heavy to be lifted by one person. Obtain assistance from others before lifting.</li> </ul>

**READ AND SAVE THESE INSTRUCTIONS**

**SPECIFICATIONS**

Model                   MSV3100  
Max Pressure\*       3100 PSI  
Max Flow\*             2.6 GPM

\* Water flow and maximum pressure ratings determined in accordance with PWMA standard PW101.

NOTE: Photographs and line drawings used in this manual are for reference only and do not represent a specific model.

## CARTON CONTENTS

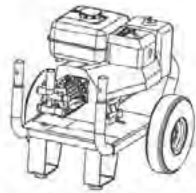

Engine Frame  
and Wheel  
Assembly

Operation  
Manual

Engine  
Manual



Nozzle  
Cleaning  
Tool



Quick  
Connect  
Nozzles



High Pressure  
Hose

Bagged Parts



Spray Gun

Quick Connect Spray Wand



Handle

## ASSEMBLY INSTRUCTIONS

- 1) Locate and remove all loose parts from the carton.
- 2) Cut the four corners of the carton from top to bottom and lay the panels flat.

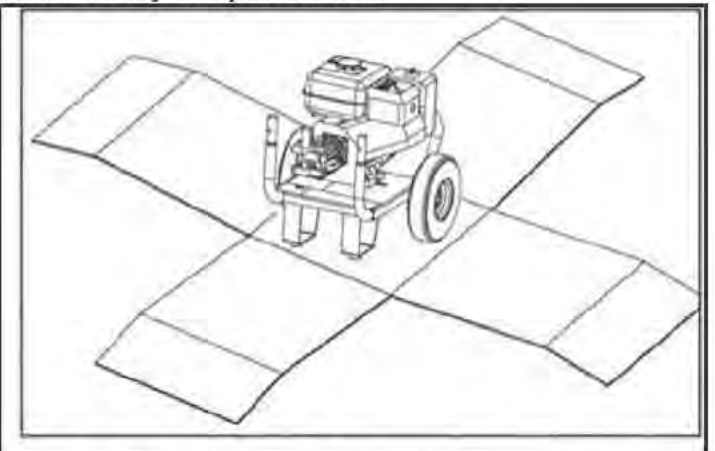
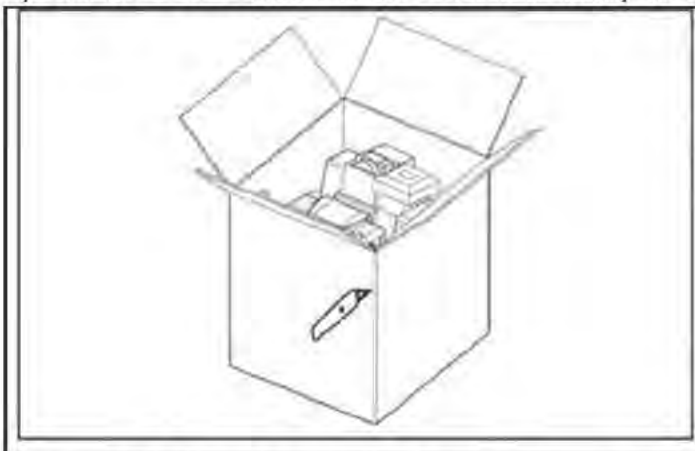

- 3) Place the handle onto the frame, depress the snap buttons, and slide the handle assembly down on the frame until snap buttons snap into place.

**CAUTION:** Risk of Personal Injury. Avoid placing hands between the handle and frame when assembling to prevent pinching.

- 4) Connect Gun to Wand. Tighten Securely.
- 5) Attach high pressure hose to gun. Tighten securely.
- 6) Remove the colored quick connect nozzle from plastic bag and insert them into grommets on the nozzle holder.

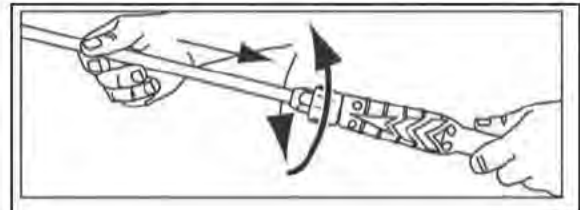



NOTE: The pump on this unit is maintenance free and requires no oil. If there is a problem with the pump, contact our Customer Service Group on [www.power-washer.us](http://www.power-washer.us) as soon as possible.

**⚠WARNING:** Risk of bursting. Use a tire pressure gauge to check the tire pressure before each use and while inflating tires; see the tire sidewall for the correct tire pressure.

NOTE: Air tanks, compressors, and similar equipment used to inflate tires can fill small tires similar to these very rapidly. Adjust pressure regulator on air supply to no more than the rating of the tire pressure. Add air in small increments and frequently use the tire gauge to prevent over inflation.

## OPERATING INSTRUCTIONS

Compare the illustrations with your unit to familiarize yourself with the location of various controls and adjustments. Save this manual for future reference.

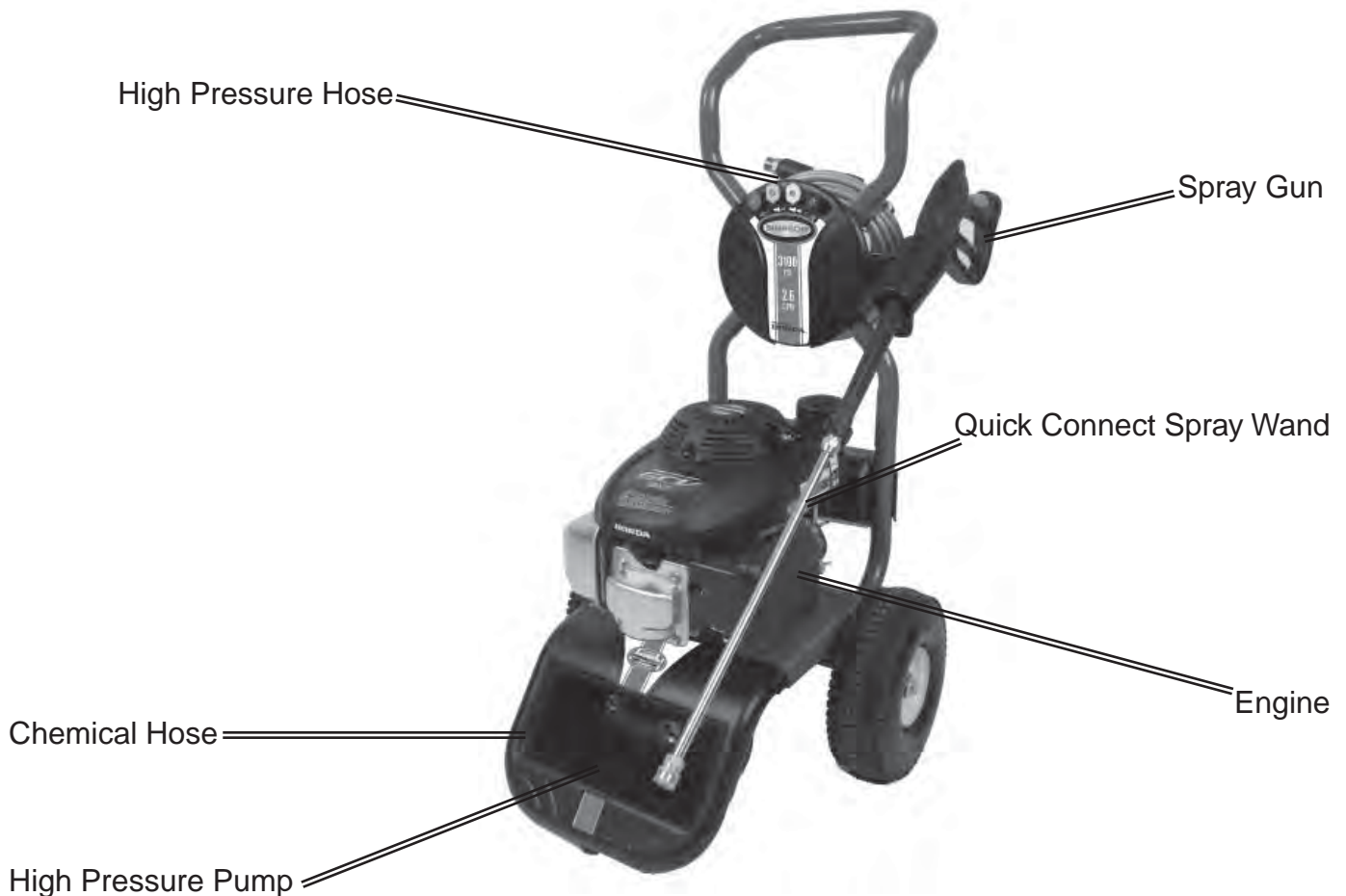

### BASIC ELEMENTS OF A PRESSURE WASHER

**High Pressure Pump:** Increases the pressure of the water supply.

**Engine:** Drives the high pressure pump. Refer to the engine manual for location and operation of engine controls

**High Pressure Hose:** Carries the pressurized water from the pump to the gun and spray wand.

**Spray Gun:** Connects the spray wand to control water flow rate, direction, and pressure.

**Quick Connect Spray Wand:** Allows the user to quickly change the spray pattern. See next sections for more details on your specific Spray Wand included with your machine.

**Chemical Hose:** Feeds cleaning agents into the pump to mix with the water. See How to Apply Chemicals / Cleaning Solvents instructions.

## BASIC ELEMENTS OF AN ENGINE

Refer to the engine manual for location and operation of engine controls.

**Choke Control:** Opens and closes carburetor choke valve.

**Starter Grip:** Pulling starter grip operates recoil starter to crank engine.

**Engine Switch:** Enables and disables ignition system.

## PRESSURE WASHER TERMINOLOGY

**PSI:** Pounds per Square Inch. The unit of measure for water pressure. Also used for air pressure, hydraulic pressure, etc. Sometimes noted as “Bar”, another unit of measure.

**GPM:** Gallons per Minute. The unit of measure for the flow rate of water. Sometimes noted as L/min (Liters per Minute).

**CU:** Cleaning Units. GPM multiplied by PSI equals CU.

**Bypass Mode:** Allows water to re-circulate within the pump when the gun trigger is not pulled. This feature allows the operator to release the trigger gun and reposition themselves without having to turn the engine off in between cleaning actions.

**CAUTION:** Allowing the unit to run for more than two minutes without the gun trigger being pulled could cause overheating and damage to the pump. Do not let the pressure washer run for more than two minutes in Bypass Mode. Turn off the engine and relieve the pressure in the gun during these extended situations.

**Thermal Relief Valve (not shown):** When the temperature inside the pump rises too high, this valve will open and release a gush of water in an effort to lower the temperature inside the pump. The valve will then close.

**Chemical Injection System:** Mixes cleaners or cleaning solvents with the water to improve cleaning effectiveness. Depending on your machine, this could either be a Detergent Siphon Tube (which is inserted into a container of detergent), or a Detergent Tank (which is filled with detergent and is an integral part of the pressure washer frame).

**Water Supply:** All pressure washers must have a source of water. The minimum requirements for a water supply are 20 PSI and 5 Gallons Per Minute.

## PRESSURE WASHER OPERATING FEATURES - SPRAY WAND

**Spray Wand:** There are two types of spray wands that can be included with your pressure washer. Check Carton Contents section of this manual to see which Wand your pressure washer uses.

**1) Variable Spray Wand.** This wand includes both high and low pressure settings. The high pressure setting is for cleaning and rinsing, and the low pressure setting is for applying chemicals or cleaning solutions to surfaces.

**⚠ DANGER:** Risk of fluid injection. Do not direct discharge stream toward persons, unprotected skin, eyes, or any pets or animals. Serious injury will occur.

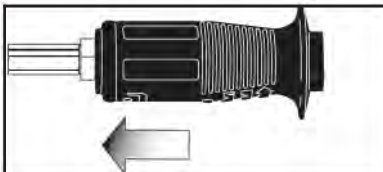

For high pressure operation, pull back the nozzle of the multi-adjustable spray wand as shown.

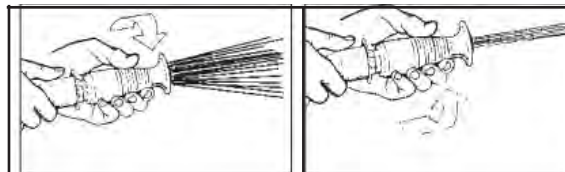

The nozzle at the end of the variable spray wand can be rotated to change from the high pressure spray pattern from a 0° pencil stream to a 40° fan spray, as shown. Markings have been placed on the nozzle to help you select the spray pattern.

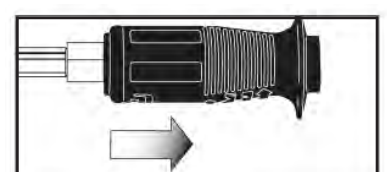





For low pressure operation and detergent application, extend the nozzle of the variable spray wand as shown.

## PRESSURE WASHER OPERATING FEATURES - SPRAY WAND

**CAUTION:** The powerful spray from your pressure washer is capable of causing damage to surfaces such as wood, glass, automobile paint, auto striping and trim, and delicate objects such as flowers and shrubs. Before spraying, check the items to be cleaned to assure yourself that it is strong enough to resist damage from the force of the spray.

**2) Quick Connect Nozzle Wand.** This model may include a variety of quick connect nozzles with different spray patterns. This Wand is commonly found on pressure washers with a PSI rating above 2500 PSI. The chart below explains the differences in the various nozzles. Note that not all machines are shipped with every nozzle - check Carton Contents section of this manual to see which nozzles, if any, are included with your pressure washer.

Nozzle Color	Spray Pattern	Uses	Surfaces*
Red	0° 	Extreme cleaning of very hard surfaces covered in grease and oil.	Steel, Undamaged Concrete.
Yellow	15° 	Intense cleaning of unpainted hard surfaces.	Grills, driveways, concrete or brick walkways, unpainted brick or stucco.
Green	25° 	Standard cleaning nozzle for most applications.	Yard tools, sidewalks, lawn furniture, unpainted siding, stucco, gutters and eaves, concrete, brick surfaces.
White	40° 	Cleaning of painted or delicate surfaces.	Auto/RV, marine, wood, painted brick and stucco, vinyl, painted siding.
Black	Low Pressure 	Applies cleaning solutions.	Low pressure spray is safe on all surfaces. Always verify compatibility of cleaning solution prior to use.

**CAUTION:** \* The powerful spray from your pressure washer is capable of causing damage to surfaces such as wood, glass, automobile paint, auto striping and trim, and delicate objects such as flowers and shrubs. Before spraying, check the items to be cleaned to assure yourself that it is strong enough to resist damage from the force of the spray.

### Changing Nozzle on the Spray Wand

**▲DANGER:** Risk of fluid injection. Do not direct discharge stream toward persons, unprotected skin, eyes, or any pets or animals. Serious injury will occur.

**▲WARNING:** Flying objects could cause risk of serious injury. Do not attempt to change nozzles while pressure washer is running. Turn engine off before changing nozzles.

**▲WARNING:** Flying objects could cause risk of serious injury. Ensure nozzle is completely inserted in quick connect socket snap ring is fully engaged (forward) before squeezing gun trigger.

## Changing Nozzles on Spray Wand (continued)

- 1) Pull quick connect coupler back and insert nozzle.
- 2) Release quick connect coupler and twist nozzle to make sure it is secure in the coupler.



## How to Apply Chemicals / Cleaning Solvents

Applying chemicals or cleaning solvents is a low pressure operation. If your pressure washer is equipped with a detergent siphon hose, follow steps 1-4. If your pressure washer is equipped with an on-board detergent tank, follow steps 5-8:

### DETERGENT SIPHON HOSE

- 1) Press chemical hose onto the barbed fitting located near the high pressure hose connection on the pump.
- 2) Place other end of chemical hose with filter on it into container holding chemical/cleaning solution.  
**NOTE:** For every 7 gallons of water pumped, one gallon of chemical/cleaning solution will be used.
- 3) Set your Wand to Low Pressure Setting either by inserting the Black Nozzle into your Wand or pulling the Variable Wand Nozzle outwards. See How To use Spray Wand section in this owners manual.
- 4) After use of chemicals, place chemical hose into container of clean water and draw clean water through chemical injection system to rinse thoroughly. If chemicals remain in the pump it could be damaged. Pumps damaged due to chemicals will not be covered under warranty.

### DETERGENT TANK

- 5) Fill your detergent tank with pre-mixed cleaning solutions designed for pressure washer use.
- 6) Check and make sure the "On-Off" valve for the tank is in the "On" position.  
**NOTE:** For every 7 gallons of water pumped, one gallon of chemical/cleaning solution will be used.
- 7) Set your Wand to Low Pressure Setting either by inserting the Black Nozzle into your Wand or pulling the Variable Wand Nozzle outwards. See How To use Spray Wand section in this owners manual.
- 8) After use of chemicals, refill your detergent tank with clean water and operate your chemical injection system to rinse it thoroughly. If chemicals remain in the pump it could be damaged. Pumps damaged due to chemicals will not be covered under warranty.

**NOTE:** Only use soaps and chemicals designed for pressure washer use. Do not use bleach!

**NOTE:** Chemicals and soaps will not siphon when Variable Spray Wand is in the High Pressure Setting, or if the Quick Connect Spray Wand is equipped with the Red, Yellow, Green, or White Nozzles.

**CAUTION:** Risk of property damage. Never pull water supply hose to move pressure washer. This could damage the hose and/or the pump inlet.

- Do not use Hot water, only use cold water.
- Never turn water supply off while pressure washer engine is running, or damage to the pump will occur!
- Do not stop spraying water for more than two minutes at a time. Pump operates in bypass mode when spray gun trigger is not pressed. If pump is left in bypass mode for more than two minutes internal components of the pump can be damaged.

**If you do not understand these precautions, please go to [www.power-washer.us](http://www.power-washer.us) to speak to a service representative for further instructions.**



## Starting Your Pressure Washer

Prior to starting, refer to your Engine Owners Manual for the proper starting procedure.

- 1) In a well ventilated outdoor area add fresh, high quality, unleaded gasoline with a pump octane rating of 86 or higher. Do not overfill. Wipe up spilled fuel before starting engine. Refer to Engine Owners Manual for correct procedure and fuel information.
- 2) Check engine oil level. See Engine Owners Manual for correct procedure.
- 3) Connect the water hose to the water source. Turn the water source on to remove all air from the hose. When a steady stream of water is present, turn the water source off.
- 4) Verify the filter screen is in the water inlet of the pump.
- 5) Connect water source to pump inlet. NOTE: Water Source must provide a minimum of 5 gallons (18.9 liters) per minute at 20 PSI (137.9kPa).

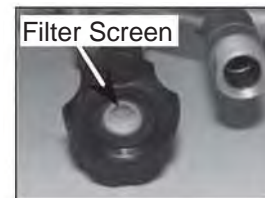

**▲WARNING:** To reduce the possibility of contamination always protect against backflow when connected to a potable water system.

- 6) Connect high pressure hose to pump outlet.
- 7) If applying a chemical or cleaning solution, see How To Apply Chemicals/Cleaning Solvents instructions in this manual.
- 8) Turn water source on.
- 9) Remove all air from the pump and high pressure hose by depressing trigger until a steady stream of water is present.
- 10) Start engine. See Engine Owners Manual for correct procedure.

**▲WARNING:** Risk of unsafe operation. If engine does not start after two pulls, squeeze trigger of gun to relieve pump pressure. Pull starter cord slowly until resistance is felt, then pull cord rapidly to avoid kickback and prevent hand or arm injury.

- 11) Depress trigger on gun to start water flow.

**▲WARNING:** Risk of unsafe operation. Stand on a stable surface and grip gun/spray wand firmly with both hands. Expect the gun to kick when triggered.

- 12) Release trigger to stop water flow.

**▲DANGER:** Risk of injury from spray. Always engage the trigger lock when gun is not in use. Failure to do so can cause accidental spraying.

- 13) Adjust Variable Spray Wand for task, or change Quick Connect Nozzle based on the task at hand.



## Shutting Down Your Pressure Washer

- 1) After each use, if you have applied chemicals, clean your chemical system as described in How to Apply Chemicals / Cleaning Solvents section on previous page.

**CAUTION:** Risk of Property Damage. Failure to clean chemical system could result in damage to the pump.

- 2) Turn off the Engine. See Engine Owners Manual for complete details.

**CAUTION:** Risk of property damage. Never turn the water off with the engine running.

- 3) Turn off the water source.
- 4) Pull trigger on spray gun to relieve any water pressure in the hose or spray gun.
- 5) See Storage section in this manual for proper procedures.



# MAINTENANCE

**▲WARNING:** Risk of burn hazard. When performing maintenance, you may be exposed to hot surfaces, water pressure, or moving parts that can cause serious injury or death.

**▲WARNING:** Risk of fire hazard. Always disconnect spark plug wire, let engine cool, and release all water pressure before performing any maintenance or repair. The engine contains flammable fuel. Do not smoke or work near open flames while performing maintenance.

To ensure efficient operation and longer life of your pressure washer, a routine maintenance schedule should be prepared and followed. If the pressure washer is used in unusual conditions, such as high-temperatures or dusty conditions, more frequent maintenance checks will be required.

## ENGINE

Consult the Engine Owners Manual for the manufacturer's recommendations for any and all maintenance. NOTE: The engine drain plug is located at the rear of the unit.

## PUMP

The pump was filled with oil at the factory. The pump on this unit is maintenance free and requires no oil. If there is a problem with the pump contact us at [www.power-washer.us](http://www.power-washer.us)

## NOZZLE CLEANING

If the nozzle becomes clogged with foreign materials, such as dirt, excessive pressure may develop. If the nozzle becomes partially clogged or restricted, the pump pressure will pulsate. Clean the nozzle immediately using the nozzle kit supplied and the following instructions:

- 1) Shut off the pressure washer and turn off the water supply.
- 2) Pull trigger on gun handle to relieve any water pressure.
- 3) Disconnect the spray wand from the gun.

**NOTE:** If you have a variable Spray Wand, continue with step #4. If you have Quick Connect Nozzles, proceed ahead to step #8.

- 4) Remove the nozzle from the end of the wand with a 2mm Allen Wrench as shown.



- 5) Clean the nozzle using the nozzle cleaner provided, or a straightened paper clip. Insert into the nozzle end and work back and forth until the obstruction is removed.



- 6) Direct water supply into nozzle end to backflush loosened particles for 30 seconds.

- 7) Insert the nozzle back into the wand using a 2mm Allen Wrench, and tighten securely.

- 8) Remove the high-pressure nozzle from the spray wand. Remove any obstructions with the nozzle cleaning tool provided, or a straightened paper clip, and work back and forth until the obstruction is removed.

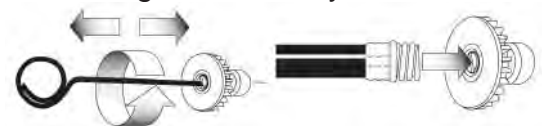

- 9) Direct water supply into nozzle end to backflush loosened particles for 30 seconds.

- 10) Reassemble the nozzle to the wand.

## CLEAN THE WATER INLET FILTER

This screen filter should be checked periodically and cleaned if necessary.

- 1) Remove filter by grasping end and removing it from water inlet of pump.
- 2) Clean filter by flushing it with water on both sides.
- 3) Re-insert filter into water inlet of pump.

NOTE: Do not operate the pressure washer without filter properly installed.



## STORAGE

### ENGINE

Consult the Engine Owners Manual for manufacturer's recommendations for storage.

### PUMP

The manufacturer recommends using a pump protector/winterizer when storing the unit for more than 30 days and/or when freezing temperatures are expected. Pump protector/winterizer is usually available at the store where the pressure washer was purchased. If a pump protector/winterizer is not available, RV antifreeze needs to be run through the pump as outlined in the steps below.

**NOTE:** Using a pump protector/winterizer or RV antifreeze is to provide proper lubrication to the internal seals of the pump regardless of temperature or environment.

- 1) Obtain a funnel, 6 ounces (170 mL) of RV Antifreeze, and a 16" to 36" (40-91cm) section of garden hose with a male hose connector attached to one end.

**CAUTION:** Risk of Property Damage. Use only RV Antifreeze. Any other antifreeze is corrosive and can damage the pump.

- 2) Disconnect the spark plug wire.
- 3) Connect the length of garden hose to the water inlet of the pump.
- 4) Add RV Antifreeze to hose as shown.
- 5) Pull starter rope slowly several times until antifreeze comes out of the high pressure hose connection of the pump.
- 6) Remove garden hose from water inlet of pump.
- 7) Reconnect spark plug wire.



### PRESSURE WASHER

- 1) Drain all water from high pressure hose, coil it, and store it in cradle of the pressure washer handle.
- 2) Drain all water from the spray gun and wand by holding spray gun in a vertical position with nozzle end pointing down and squeezing trigger. Store in gun holder.
- 3) Store chemical hose, if so equipped, so it is protected from damage.

## REPAIRS

To assure product SAFETY and RELIABILITY, repairs, maintenance, and adjustment should be performed by an Authorized Warranty Service Center. Always use identical replacement parts. For the location of the nearest Authorized Service Center go to [www.power-washer.us](http://www.power-washer.us)

## ACCESSORIES

Recommended accessories for use with our pressure washer are available for purchase from your local retailer or authorized service center. If you need assistance in locating any accessory for your pressure washer, please go to [www.power-washer.us](http://www.power-washer.us)

**▲ DANGER:** Risk of fluid injection. When using replacement lances or guns with this pressure washer, DO NOT use a lance and/or lance/gun combination that is shorter in length than what was provided with this pressure washer as measured from the nozzle end of the lance to the gun trigger.

**CAUTION:** The use of any other accessory not recommended for use with this tool could be hazardous. Use only accessories rated equal to or greater than the rating of the pressure washer.

## TROUBLE SHOOTING GUIDE

PROBLEM	CAUSE	CORRECTION
Engine will not start (see Engine manual for further troubleshooting).	No Fuel	Add fuel.
	Pressure builds up after two pulls on the recoil starter or after initial use.	Squeeze gun trigger to relieve pressure.
	Choke level in the "No Choke" position.	Move choke to the "CHOKE" position.
	Spark plug wire not attached.	Attach spark plug wire.
	Engine Switch in the "OFF" Position.	Place engine switch in "ON" Position.
	Choke lever in the "CHOKE" position on a "hot" engine or an engine that has been exposed to thermal heat for a long period of time.	Move choke to the "NO CHOKE" position.
No or low pressure (initial use).	Variable Spray Wand not in High Pressure Position.	See How to Use Spray Wand instructions.
	Low Water Supply.	Water Supply must be at least 5 GPM and 20 PSI.
	Leak at high pressure hose fitting.	Repair Leak. Apply sealant tape if necessary.
	Nozzle Obstructed.	See Nozzle Cleaning instructions.
	Water Filter Screen Clogged.	Remove and clean filter.
	Air in hose.	Turn off the engine, then the water source. Disconnect the water source from the pump inlet and turn the water source on to remove all the air from the hose. When a steady stream of water is present, turn the water source off. Re-connect water source to pump inlet and turn on water source. Squeeze trigger to remove remaining air.
Continued on next page.		

## TROUBLE SHOOTING GUIDE (continued)

PROBLEM	CAUSE	CORRECTION
No or low pressure (initial use).	Choke in the "CHOKE" Position.	Move choke to the "NO CHOKE" position.
	High pressure hose is too long.	Use high pressure hose under 100 feet (30m).
Will not draw chemicals.	Spray wand not in low pressure.	See How to Use Spray Wand section.
	Chemical filter is clogged.	Clean filter.
	Chemical screen not in cleaning solution.	Make sure end of chemical hose is fully submerged into cleaning solution.
	Chemical is too thick.	Dilute chemical. Chemical should be the same consistency as water.
	Pressure hose is too long.	Lengthen water supply hose instead of high pressure hose.
	Chemical build up in chemical injector.	Have parts cleaned or replaced by Authorized Service Center.
No or low pressure (after period of normal use).	Worn seal or packing.	Have parts cleaned or replaced by Authorized Service Center.
	Worn or obstructed valves.	Have parts cleaned or replaced by Authorized Service Center.
	Worn unloader piston.	Have parts cleaned or replaced by Authorized Service Center.
Water leaking at gun/spray wand connection.	Work or broken o-ring.	Check and Replace
	Loose Hose Connection.	Tighten.
Water leaking at pump.	Loose Connections.	Tighten.
	Piston packings worn.	Have parts cleaned or replaced by Authorized Service Center.
	Work or broken o-rings.	Have parts cleaned or replaced by Authorized Service Center.
	Pump head or tubes damaged from freezing.	Have parts cleaned or replaced by Authorized Service Center.
Pump pulsates.	Nozzle Obstructed.	See Nozzle Cleaning paragraph in MAINTENANCE section for the correct procedure.

# WARRANTY STATEMENT

At **SIMPSON CLEANING SYSTEMS**, we only distribute top quality industrial / commercial / personal pressure washers that are designed for light- and heavy-duty use, maximum reliability, durability, and long life. Our pressure washers are built for their respective duty applications and steady use due to higher quality levels.

The manufacturer of this product agrees to repair or replace designated parts that prove defective within the warranty period listed in the chart below. Specific limitations/extensions and exclusions apply, and are listed in the chart below. This warranty covers defects in material and workmanship and not parts failure due to normal wear, depreciation, abuse, accidental damage, negligence, improper use, maintenance, or storage. To make a claim under the terms of the warranty, all parts said to be defective must be available or returned (if requested) to a SIMPSON CLEANING SYSTEMS designated Warranty Service Center for warranty inspection. The judgments and decisions of the Warranty Service Center concerning the validity of warranty claims are final.

These warranties pass through to the end user. As a factory authorized and trained Warranty Service Center the factory will honor the terms of all component warranties and satisfy claims of the appropriate warranty provisions.

Normal wear items include, but are not limited to, Valves and Seals, which are not covered by this warranty.

This Warranty replaces all other warranties, express or implied, including without limitation any warranties of merchantability or fitness for a particular purpose and all such warranties are hereby disclaimed and excluded by the manufacturer. The Manufacturer's warranty obligation is limited to repair and replacement of defective products as provided herein and the Manufacturer shall not be liable for any further loss, damages, or expenses – including damages from shipping, accident, abuse, acts of God, misuse, or neglect. Neither is damage from repairs using parts nor purchased from the manufacturer or alterations performed by non-factory authorized personnel. Failure to install and operate equipment according to the guidelines put forth in the instruction manual shall void warranty.

This warranty does not cover the following: machines used for rental purposes, damage resulting from shipping (claims must be filed with shipping company), accident, abuse, act of God, misuse, or neglect. Neither is damage from repairs or alterations performed by non-factory authorized personnel or failure to install and operate equipment according to the guidelines put forth in the instruction manual.

The manufacturer will not be liable to any persons for consequential damage, for personal injury, or for commercial loss.

**SIMPSON WARRANTY CONTINUED ON NEXT PAGE**



# Warranty Period and Details for Specific Parts & Components

## **High Pressure Electric Axial Pumps:**

One (1) year on pump & motor workmanship, defects, or material.

Warranty does not apply to failures on other pump parts due to:

- Freight damage
- Freeze damage
- Damage caused by parts or accessories not obtained from / or approved by SIMPSON CLEANING SYSTEMS
- Normal wear of moving parts or components affected by moving parts
- Unfiltered Hard Water

## **High Pressure Gas Axial Pump:**

One (1) year on pump workmanship, defects, or material.

Warranty does not apply to failures on other pump parts due to:

- Freight damage
- Freeze damage
- Damage caused by parts or accessories not obtained from / or approved by SIMPSON CLEANING SYSTEMS
- Normal wear of moving parts or components affected by moving parts
- Unfiltered Hard Water

## **High Pressure Triplex Pump:**

Five (5) years on pump workmanship, defects, or material.

Lifetime Warranty on the forged brass manifold.

This warranty is covered by the Triplex Pump Manufacturer's Warranty (included with Pressure Washer when shipped).

Warranty does not apply to failures on other pump parts due to:

- Freight damage
- Freeze damage
- Damage caused by parts or accessories not obtained from / or approved by SIMPSON CLEANING SYSTEMS
- Normal wear of moving parts or components affected by moving parts.

## **Engine:**

The engine warranty is covered under the terms and conditions as outlined by the engine manufacturer's warranty (included with the owner's manual) and is the sole responsibility of the engine manufacturer.

## **Machine Steel Frame:**

One (1) year from date of first start up.

## **Accessories:**

Ninety (90) days. Includes tips, guns, wands, injectors, unloaders, hose reel, brushes, foamers, GFCI units, thermal relief, filters, tanks, wheels, tires, etc.



Simpson Cleaning Systems © 2010, a division of The FNA Group. All Rights Reserved. In our effort towards continuous improvement, specifications are subject to change without notice.

1825 Greenleaf Avenue Elk Grove Village, IL 60007 [www.power-washer.us](http://www.power-washer.us)